

# #10533

## SEW COOL PRODUCTIONS: THE BASICS OF SEWING

LEARNING ZONE EXPRESS, 2000  
Grade Level: 6-13+  
27 Minutes  
9 Instructional Graphics Included



**CAPTIONED MEDIA PROGRAM RELATED RESOURCE**

[#10532 SEE 'N SEW](#)



## Teacher's Guide

### Hand Stitching



#### Goals:

---

- Thread needle, tie knot, and sew basic hand stitches used in repairing clothes.
- Sew on different types of buttons.

#### Lesson Outline:

---

1. **Worksheet: Hand Stitches.** Create samples of each hand stitch on large pieces of felt (mount them on poster board or attach to bulletin board). Pre-cut 6" squares of fabric for this assignment. Demonstrate how to do each stitch with a large needle on felt pieces, then have students practice. Have students do one quality row of each stitch and turn it in for grading.
2. **Worksheet: Sewing on Buttons.** Create samples of each button type sewn on to pieces of felt (mount them on poster board or attach to bulletin board). Pre-cut squares of fabric and collect the three types of buttons for this assignment. Demonstrate how to sew on each type of button (2-hole, 4-hole, and shank) with a large needle on felt pieces. Have students sew one of each type of button on fabric square and turn it in for grading.

### Clothing Construction

#### Goals:

---

- Recognize names and uses of sewing equipment
- Outline safety practices to follow when working in sewing lab.
- Interpret pattern markings and pattern layout diagrams.
- Correctly thread the sewing machine.
- Stitch straight lines with backstitching, square corners, 1/2" seam, and ziz-zag stitch.

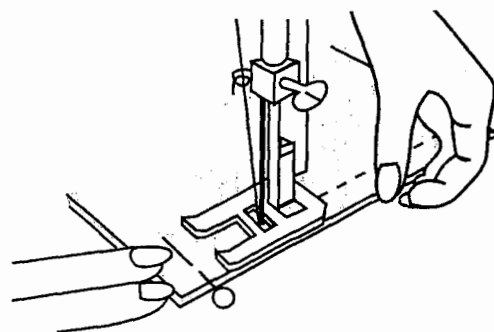

## Lesson Outline:

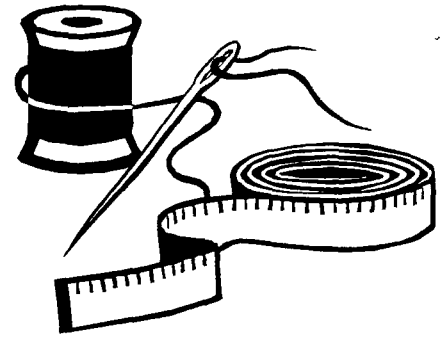

1. **Worksheet: Sewing Tool Identification.** Show the sewing equipment pieces and demonstrate their use as the students complete this worksheet. Outline safety practices to prepare them for sewing lab.
2. **Worksheet: Fabric Terms & Pattern Symbols.** Prepare for this lesson by having 1" pieces of the following fabrics: woven, knit, corduroy, selvage edge, right side/wrong side of fabric. Have a pattern and instruction sheet to refer to during your discussion. Follow directions on the worksheet. Students roll up tape to attach samples in the spaces indicated as you talk about the samples.

### Worksheet Answers:

- |   |   |
|---|---|
| 1. unravels easily, very little stretch, needs a seam finish, not a good choice for athletic wear.                              | 8. 5/8", 5  |
| 2. stretches more in one direction than the other, no seam finish needed, looks like a chain-link fence, good for athletic wear | 9. dart   |
| 3. answers vary   | 10. seam  |
| 4. Nap  | 11. right   |
| 5. Selvage  | 12. basting   |
| 6. outside, inside  | 13. baste, then pull threads (have example stitched to show students) |
| 7. draw symbols, show students symbols on pattern pieces  | 14. beginning and end of seam   |
|   | 15. so seams don't come out   |
|   | 16. helps sew pieces together accurately                              |
|   | 17. list your sewing lab rules here                                   |

3. Make copies of a **Machine Diagram** of the sewing machines in your classroom (from the manuals of your specific machines) and have the students label each part of the machine as you explain it. Demonstrate how to thread the machine, backstitch, straight stitch, and zig-zag on scraps of fabric.
4. **Worksheet: Machine Stitching.** Create samples of each machine stitch on fabric with contrasting thread as shown on the assignment (mount them on poster board or attach to bulletin board). Pre-cut 6" squares of solid fabric for students to practice and do their final stitching. Demonstrate the assignment as shown on the worksheet and allow students time to practice and do a final sample to turn in for grading.

# Sewing Tool Identification

Name: \_\_\_\_\_

Hour: \_\_\_\_\_

**GOAL:** ...recognize names of sewing equipment.  
...outline safety practices to follow when working in sewing lab.

**DIRECTIONS:** Fill in names of sewing equipment using the word bank below.

Hand Sewing Needles	Marking Pencil	Pin Cushion
Pinking Shears	Sewing Gauge	Pressing Ham
Seam Ripper	Scissors	Tape Measure
Straight Pins	Tailors chalk	Thimble
Tracing Paper	Tracing Wheel	
Shears	Seam Roll	

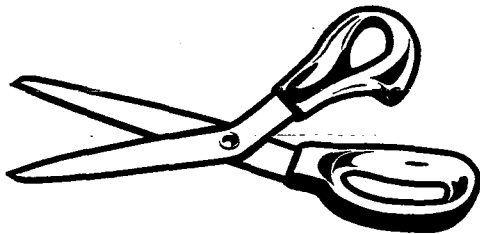

Heavy Duty cutting of fabric.  
One handle larger than other.

1.

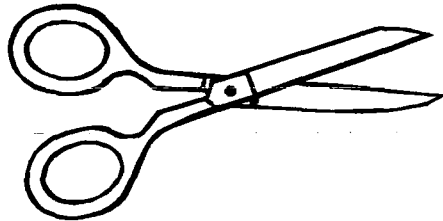

Used to trim threads.  
Two handles same size.

2.

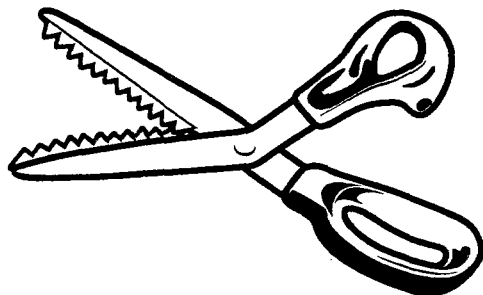

Cuts a zig-zag edge to prevent  
raveling. Makes a seam finish.

3.

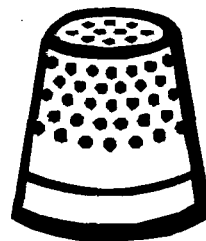

Protects your finger when  
hand sewing.

4.

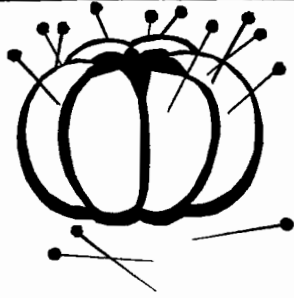

Stores pins, filled with sawdust which sharpens pins.

5.



Used to hold pattern to fabric or 2 layers of fabric. Must lay flat on fabric.

6.

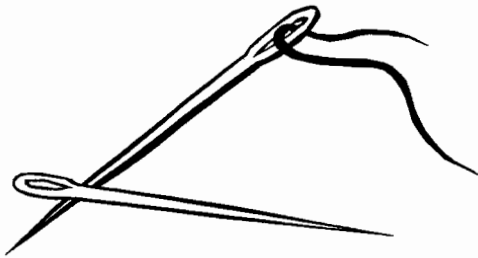

Different sizes and lengths. Used to sew by hand.

7.



Chalk-filled pencil – makes temporary marks on fabric.

8.

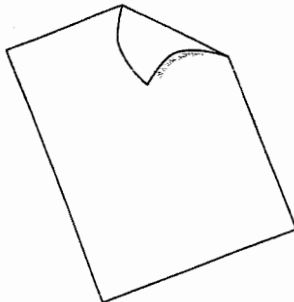

Waxy coated paper which transfers pattern markings.

9.

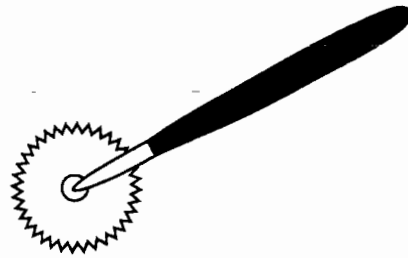

Handle & metal wheel with teeth, used with tracing.

10.

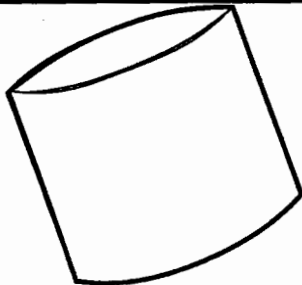

Square of chalk, makes temporary marks on fabric.

11.

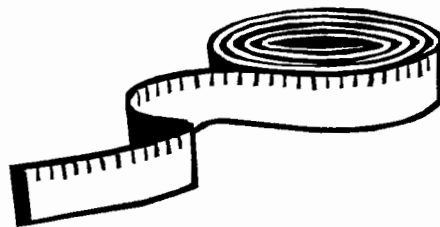

60" long, takes pattern or body measurements.

12.

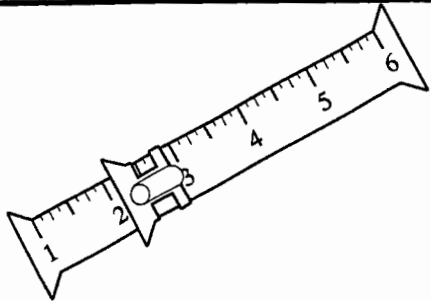
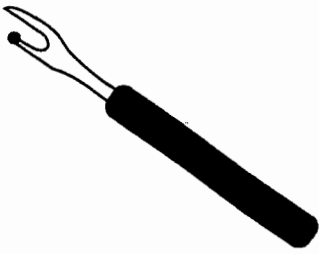
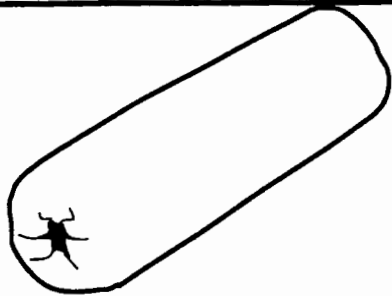
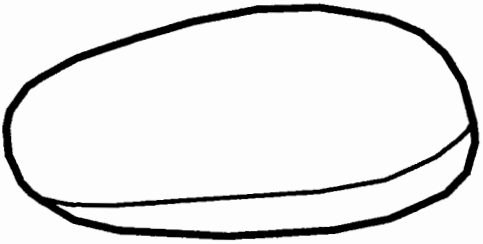
 <p>6" long with slide, helps you mark a hem or smaller amounts.</p>	 <p>Takes out sewing mistakes.</p>
13.	14.
 <p>Helps press seams in tubes – like sleeves. Looks like a sausage.</p>	 <p>Press curved areas. Looks like a ham!</p>
15.	16.

## Safety In The Sewing Lab

**DIRECTIONS:** Write down the safety rules to follow when working in the sewing lab.

---



---



---



---



---



---



---



---

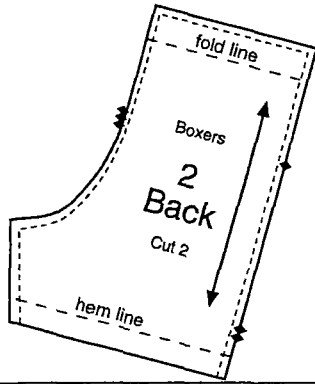

Name: \_\_\_\_\_

Hour: \_\_\_\_\_

# Fabric Terms & Pattern Symbols

**GOAL:** ...interpret pattern markings and pattern layout diagrams.

**DIRECTIONS:** Follow teacher directions in completing this assignment.

<p>1. Describe a <b>WOVEN</b> fabric: _____</p> <p>_____</p> <p>_____</p> <p>_____</p> <p>_____</p>	<p>Paste Sample Here</p>
<p>2. Describe a <b>KNIT</b> fabric: _____</p> <p>_____</p> <p>_____</p> <p>_____</p> <p>_____</p>	<p>Paste Sample Here</p>
<p>3. My shirt is a _____ fabric.</p>	<p>My pants are a _____ fabric.</p>
<p>4. _____ is the fuzzy surface on fabric.</p> <p>All pattern pieces must be laid out in the same directions.</p>	<p>Paste Sample Here</p>

5. The \_\_\_\_\_ is a tightly woven edge on fabric made during processing. It does not ravel. The grainline arrow must be parallel to this edge.

Paste  
Sample  
Here

Paste  
Sample  
Here

6. The RIGHT SIDE of the fabric is called the \_\_\_\_\_.

Paste  
Sample  
Here

The WRONG SIDE of the fabric is called the \_\_\_\_\_.

7. Draw the correct pattern symbol for each of the following:

**Notch** is used to match pattern pieces. Cut out and around to leave notch showing on the fabric.

**Place on Fold** means that you place the edge of the arrows on the fold of the fabric. Don't cut on this edge!

**Grainline Arrow** is a symbol that must be parallel to the selvage edge of fabric. Necessary so that clothes hang and wear properly.

**Dots** are used to give sewing directions during construction.

**Stitching Line** is a broken dotted line on a pattern. Normal stitching line is 5/8" from edge of the fabric.

**Cutting Line** is the heavy outside line on a pattern. Leave the line on your pattern pieces by cutting just outside the line.



## Review: Short Answer.

---

8. Normal seam allowance is \_\_\_\_\_. Line up the edge of the fabric with the number \_\_\_\_\_ on the throat plate of our machines.
9. The pattern symbol that when sewn adds shape to an area is a \_\_\_\_\_.
10. A row of stitching that joins two pieces of fabric is called a \_\_\_\_\_.
11. Most sewing is done with \_\_\_\_\_ sides of fabric together.
12. Temporary machine stitching or stitching by hand is called \_\_\_\_\_.
13. How do you gather or ruffle fabric? \_\_\_\_\_  
\_\_\_\_\_
14. Where do you backstitch? \_\_\_\_\_
15. Why do you backstitch? \_\_\_\_\_  
\_\_\_\_\_
16. What is the importance of cutting exactly next to the cutting line when you cut out your pattern pieces? \_\_\_\_\_  
\_\_\_\_\_
17. How will you practice safety when sewing? \_\_\_\_\_  
\_\_\_\_\_  
\_\_\_\_\_

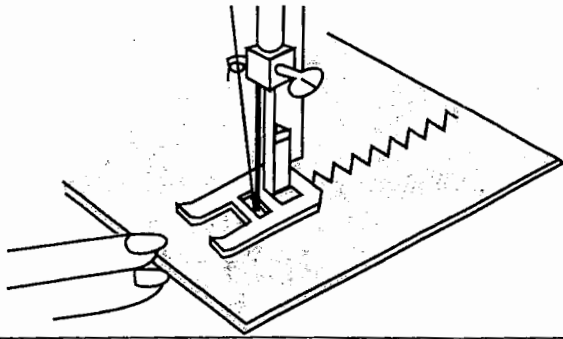

Name: \_\_\_\_\_

Hour: \_\_\_\_\_

# Machine Stitching

## GOALS:

- ...demonstrate your ability to correctly thread the sewing machine.
- ...stitch straight lines with backstitching, stitch square corners, stitch 1/2" seam.
- ...set machine to ziz-zag stitch.

1. Get a 6" square of fabric and thread machine with color that will show up on that fabric.
2. Begin in the middle of a side and stitch 1/2" from the edge all the way around the square (carefully turn square corners). Backstitch when you begin and end.
3. Inside the square stitch 2 rows of straight stitching with backstitching when you begin and end.
4. Then stitch 2 rows of zig-zag stitching.
5. Be sure all threads are trimmed.

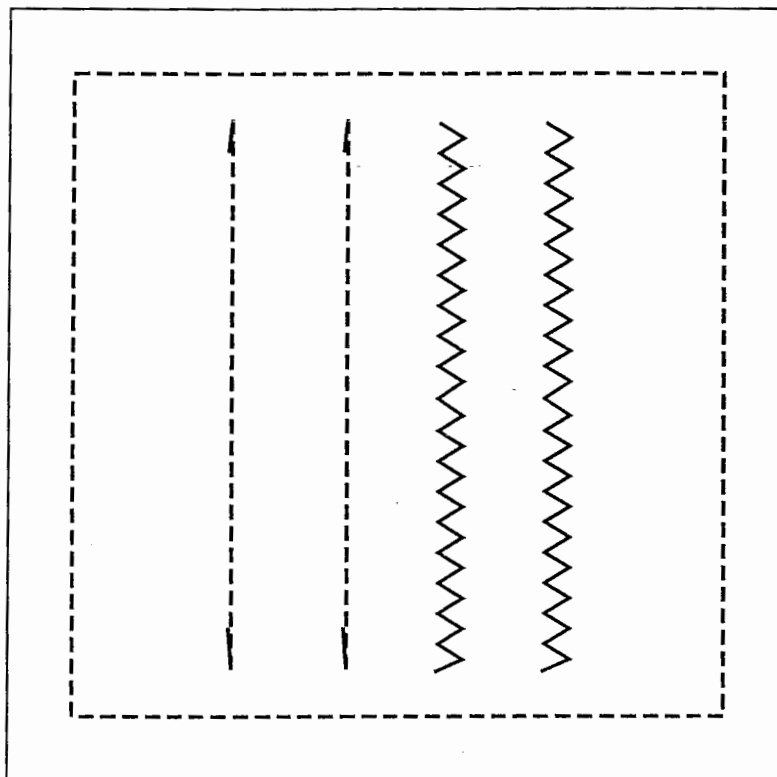

**Staple your sample here.**

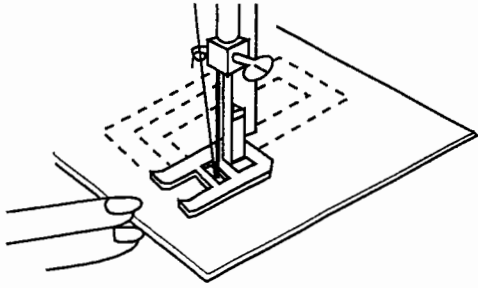

Name: \_\_\_\_\_

Hour: \_\_\_\_\_

# Paper Stitching Exercise

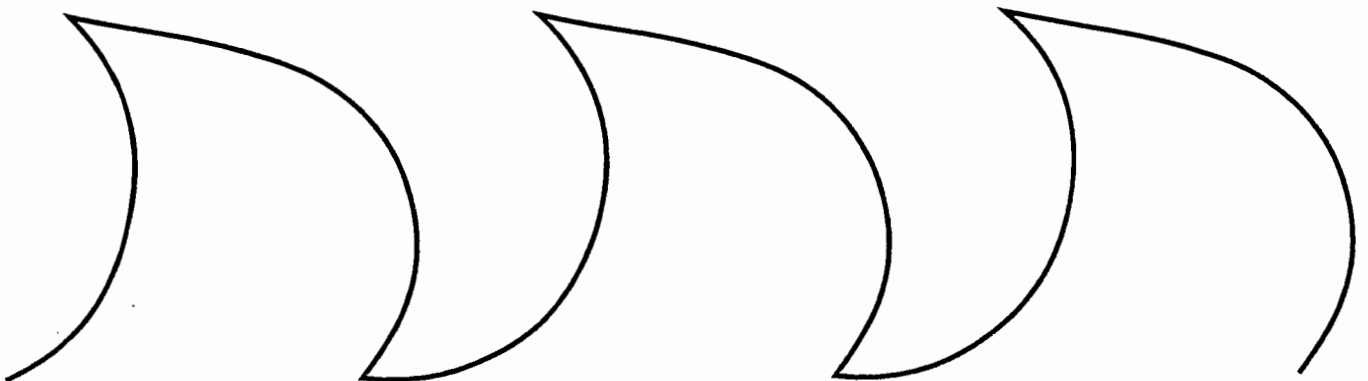
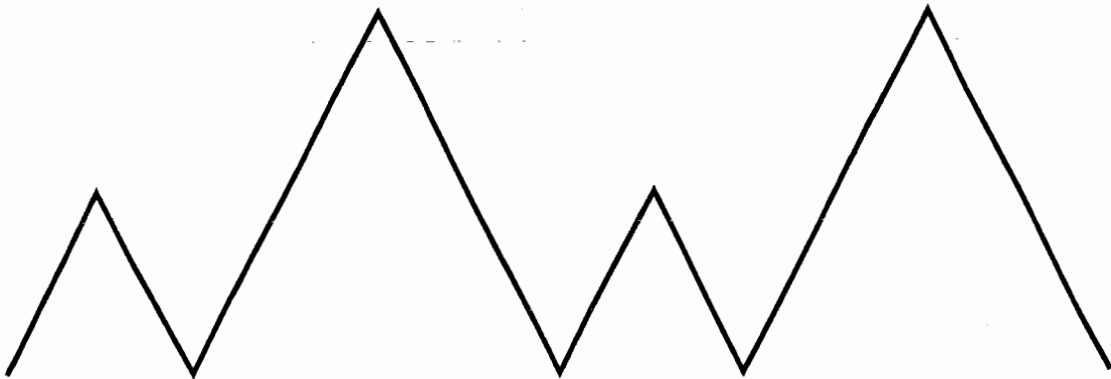
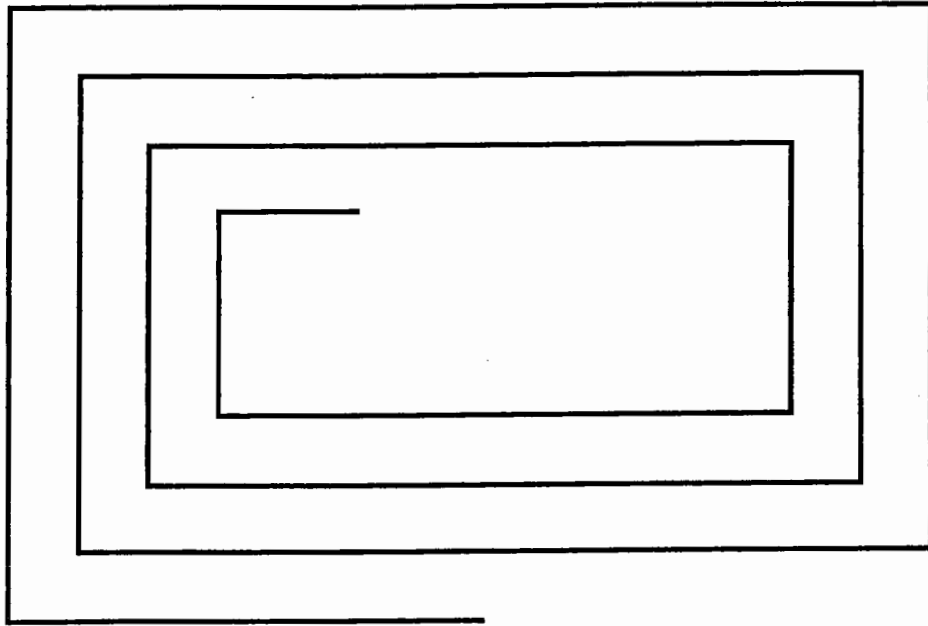

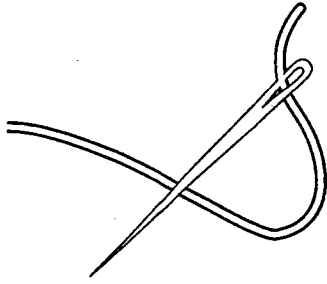

Name: \_\_\_\_\_

Hour: \_\_\_\_\_

# Hand Stitches

**GOAL:** ...be able to sew basic hand stitches – used in repairing clothes and in stitching the sewing project.

## Running Stitch

A simple stitch used for gathering, easing and swing seams with little stress. Poke up from the back of fabric, poke down and up creating a dotted line on front and back of fabric. Should be tiny and even and about 1/16-1/8" long. Do one whole row of stitches.

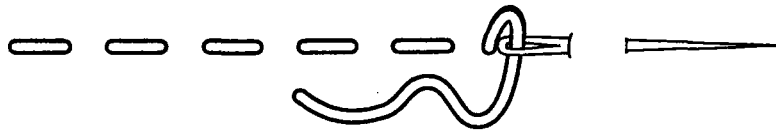

## Backstitch

A very strong stitch. Used to repair seams. Begin with a tiny running stitch, back up into the last threads, poke out under, poke through ahead of it and pull. This stitch should be about 1/4" long and make a connected line on front and back of fabric. Do a whole row of stitches.

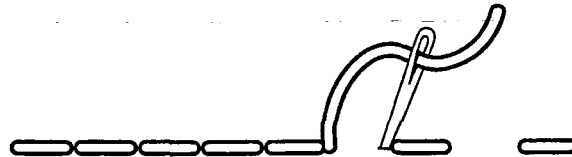

## Overcast Stitch

This is a very strong and tough stitch, sometimes called the "ugly" stitch. Put two edges of fabric together. Poke up from the bottom and pull, and then repeat, poking the needle up from the bottom. Stitches are one on top of each other and the threads wrap over the edge of fabric. Use this in seams with a lot of stress. Do 1 inch of this stitch.

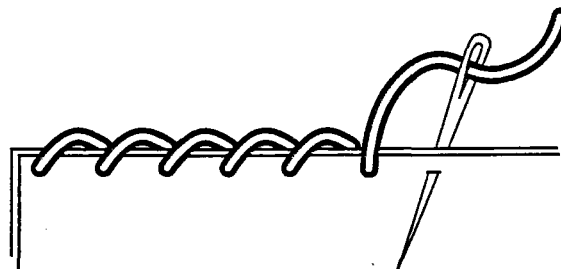

**Staple your samples here.**

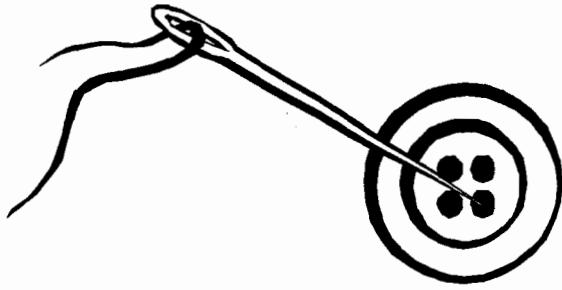

Name: \_\_\_\_\_

Hour: \_\_\_\_\_

# Sewing on Buttons

**GOAL:** ...be able to sew on buttons, use skills to repair clothes.

## 2-Hole Button

1. Thread needle with color to match button. Take a small stitch where button is to be placed. Poke needle through button hole, hold button in place over small stitch.
2. Place straight pin across top of holes. Sew with thread going over top of pin and down in opposite hole. Do this at least 6 times.
3. Remove pin. Poke needle so thread comes out under button, but on top of fabric so you can **TIGHTLY** wrap threads around the middle of the stitches 4 times. This creates a thread shank (so you have room for other layer of fabric when you button).
4. Poke needle to back of fabric. Stitch in place 3 times to make a secure knot. Trim thread.

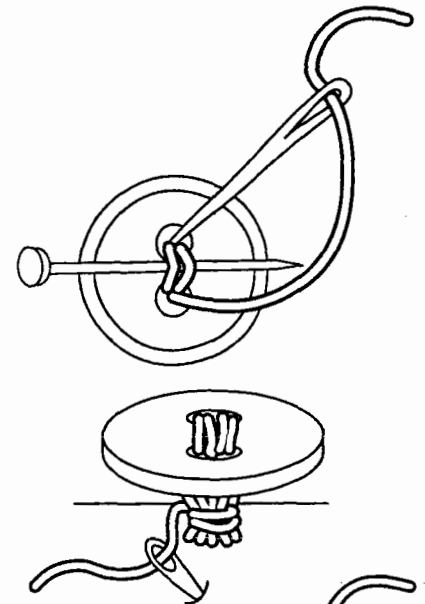

## 4-Hole Button

1. Follow directions for the 2-hole button.
2. When stitching the extra two holes, poke needle from the underside and continue so the extra thread doesn't show on the top. You must use the same thread for the entire button.

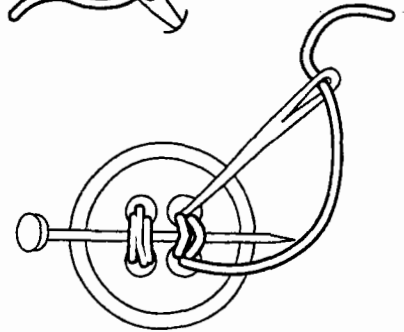

## Shank Button

1. Thread needle with color to match button and take a small stitch where button is to be placed.
2. Slip button on thread, hold button at an angle, poke up through hole, down the side of the shank and continue at least 6 times. Then just stitch in place 3 times on the back to knot thread. **DO NOT WRAP THREADS** because this button has a shank.

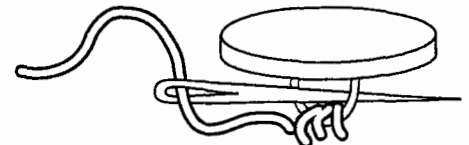

**Staple your sample here.**

# Square Pin Cushion

1. Cut two pieces of fabric 4" x 4".
2. Pin squares of fabric together with right sides facing each other.
3. Stitch together with 1/4" seam allowance. Leave a 2" opening on the center of one side. Backstitch when you begin and end (both sides of opening).
4. Trim corners, being careful not to cut your stitching. Turn right side out. Push out corners.
5. Stuff firm. Fold raw edges in and hand stitch the opening closed.

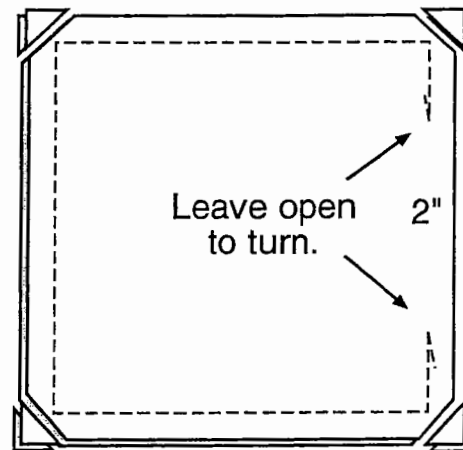
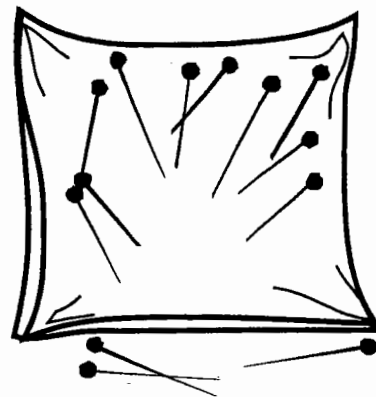

# Polar Fleece Headband

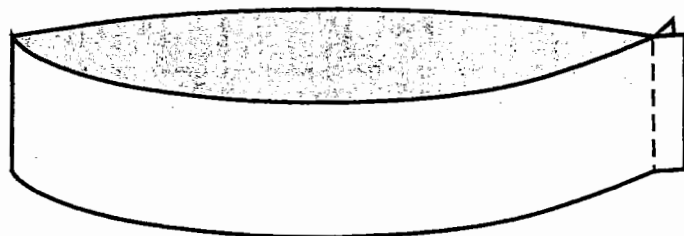
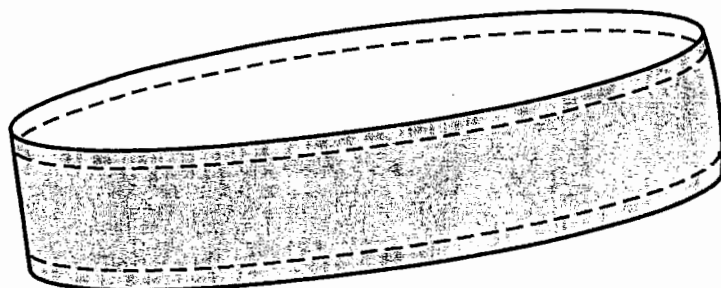

1. Measure your head where you will place the headband.
2. Cut a strip of polar fleece 3" wide and the length of your head measurement minus 3".
3. Match short edges and sew with a 5/8" seam. Backstitch at the beginning and end the seam.
4. Open and finger-press seam. Topstitch 1/4" around each side of headband, making sure the seam is flat.

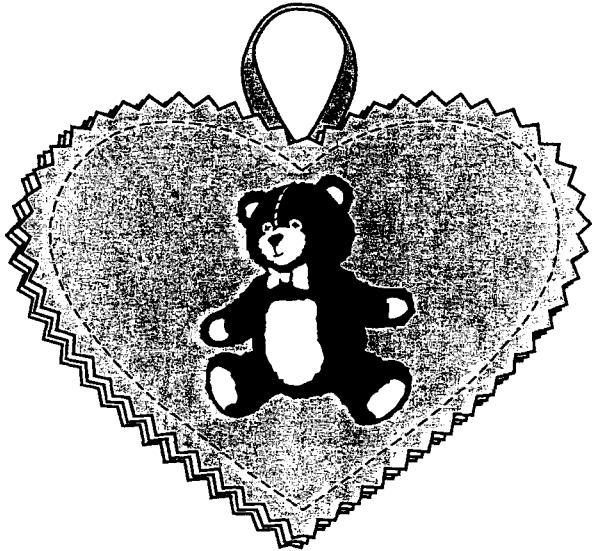

# Paper or Felt HANG-UPS

1. Cut two pieces (a front and a back) of paper\* or felt using one of the "Hang-ups" patterns or create your own pattern! Use pinking shears\*\* or straight edge shears to cut it out.
2. Cut one piece of paper towel (poly-fleece or felt) from the pattern as the "filling" or stuffing.
3. Cut 8" of 1/4" ribbon. Tap the ends of the ribbon to the wrong side of the back piece (this will be on the inside of the hang-up) as marked on pattern.
4. Sandwich the filling (paper towel or fleece) in between the top and bottom pieces, making sure that the decorated pieces are right side up and on the outside. Your ribbon "hanger" should be on the inside.
5. With threaded sewing machine, straight stitch 1/4" around the edge. Lock the stitches by stitching over several stitches where they meet.

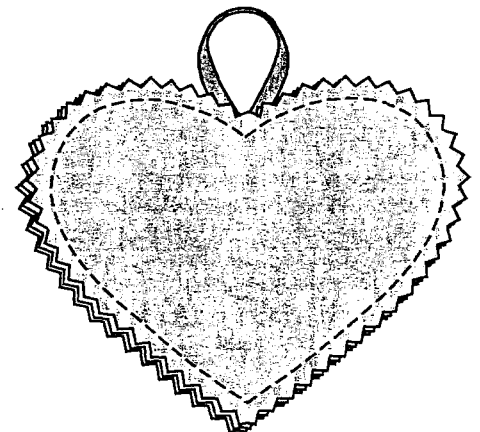
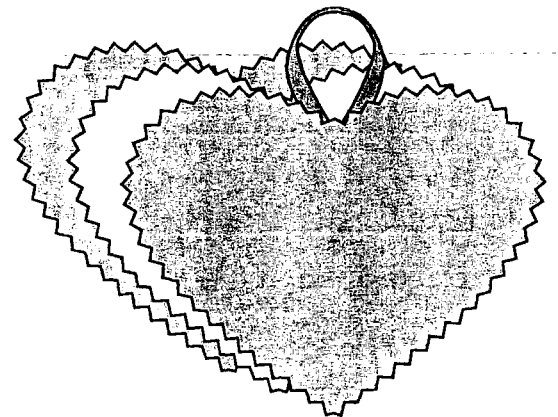
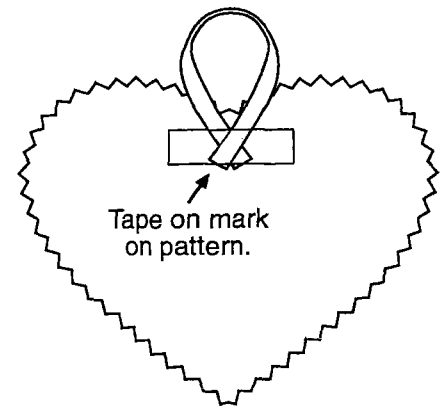

Decorations like iron-ons, fabric paint, decorative stitching, etc. can be added after Step 2 or after Step 5.

*\* Brown paper bags work great for this project!*

*\*\* When using pinking shears, you may want to layer the paper and paper towel and cut it all at one time so the edges of all the layers are even.*



Place ribbon ends here.

# HANG-UPS

Cut 2 of paper or felt.  
Cut 1 of paper towel or poly-fleece.



Place ribbon ends here.

# HANG-UPS

Cut 2 of paper or felt.  
Cut 1 of paper towel or poly-fleece.





Place ribbon  
ends here.

# HANG-UPS

Cut 2 of paper or felt.  
Cut 1 of paper towel or poly-fleece.



Place ribbon  
ends here.

# HANG-UPS

Cut 2 of paper or felt.  
Cut 1 of paper towel or poly-fleece.

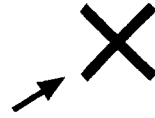
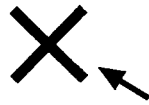

Place ribbon ends here.

# HANG-UPS

Cut 2 of paper or felt.  
Cut 1 of paper towel or poly-fleece.